

## Typical Exterior Elevations

FIXED

Scale: Not To Scale

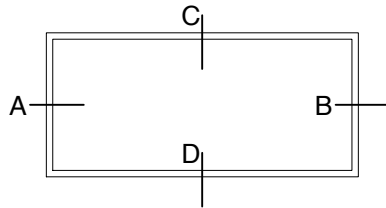

HR4511-FX

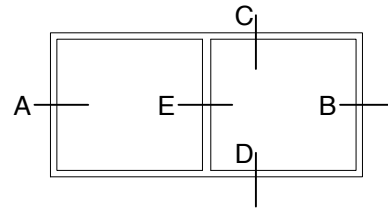

HR4521-FX

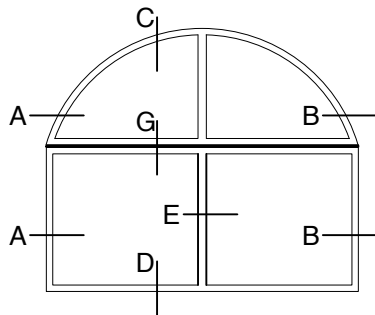

HR4522-FX2 ARCH

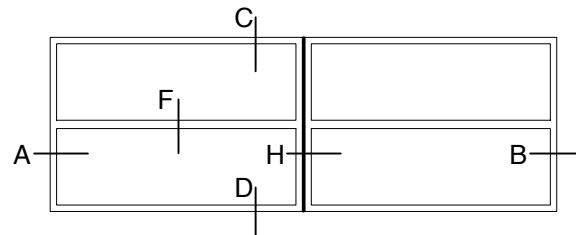

HR4522-FX2



## KEY (TYPICAL)

1. SNAP IN ALUMINUM GLAZING BEAD (OTHER OPTIONS AVAILABLE)
2. EXTRUDED SILICONE WEDGE GASKET (BY OWM)
3. GLASS AND GLAZING (BY OTHERS)
4. SILICONE CAP BEAD (BY OTHERS)
5. FOAM GLAZING TAPE (BY OTHERS)

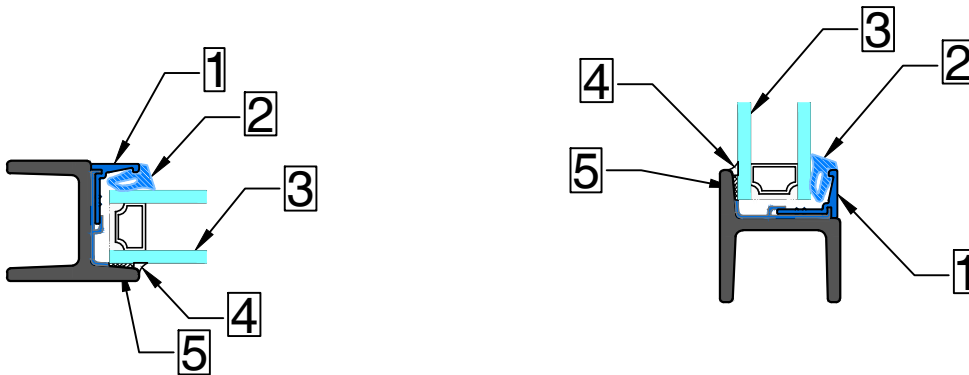

INTERIOR

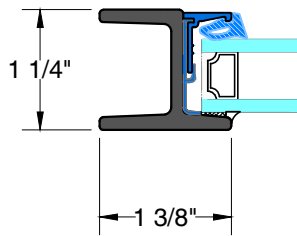

EXTERIOR



INTERIOR

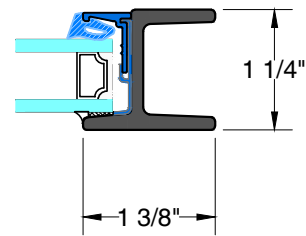

EXTERIOR



EXTERIOR

INTERIOR

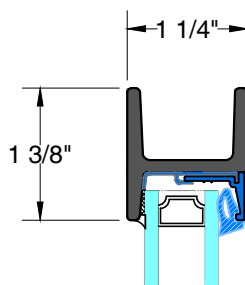

EXTERIOR

INTERIOR

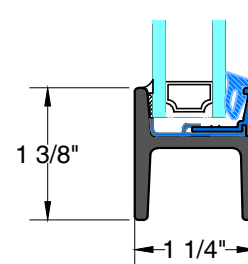

## Typical Details

**FIXED**  
Scale: Half Scale

INTERIOR

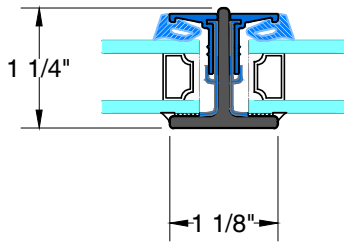

EXTERIOR

**E** **TYPICAL VERTICAL MUNTIN**

EXTERIOR

INTERIOR

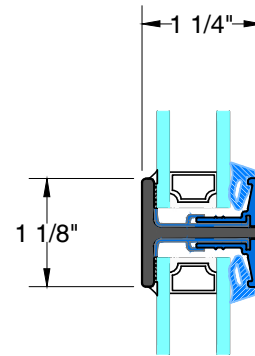

**F** **TYPICAL HORIZONTAL MUNTIN**

EXTERIOR

INTERIOR

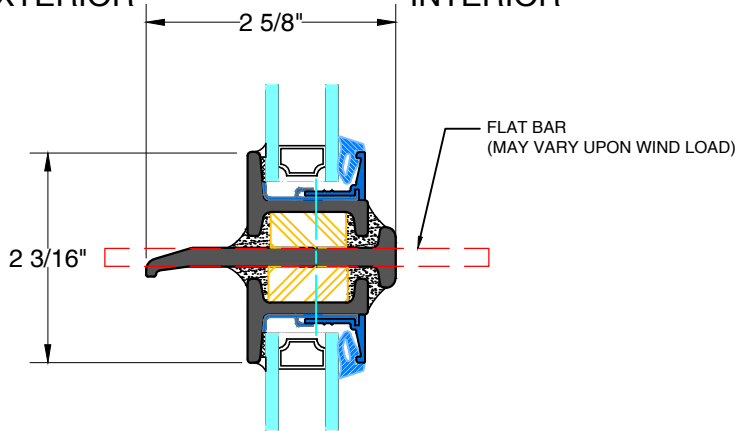

**G** **TYPICAL STACKING MULLION**

INTERIOR

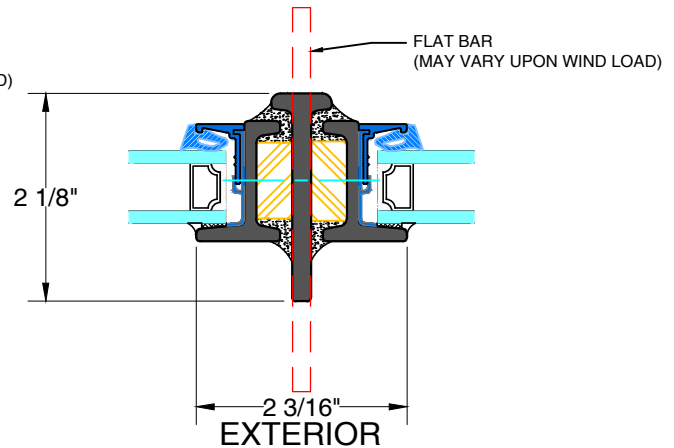

**H** **TYPICAL JOINING MULLION**



### OPTIONAL FLANGE FRAME

INTERIOR

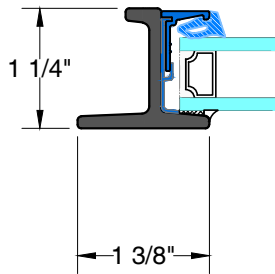

EXTERIOR

**1** TYPICAL EXTERIOR FLANGE

INTERIOR

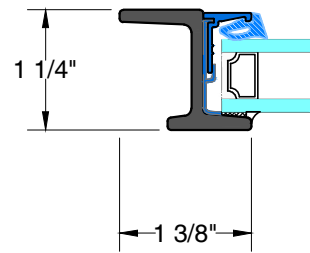

EXTERIOR

**2** TYPICAL FIXED INTERIOR FLANGE

### OPTIONAL SHORT LEG FRAME

INTERIOR

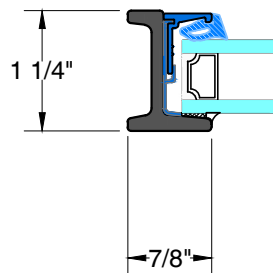

EXTERIOR

**1** TYPICAL SHORT LEG FRAME

